

CERTIFIKÁT EÚ SKÚŠKY TYPU

EU – type examination certificate

Číslo dokumentu:
Document number:

SK 20-MI001-SMU063

Revízia 0
Revision 0

V súlade s:
In accordance with:

prílohou č. 2, Modul B nariadenia vlády Slovenskej republiky č. 145/2016 Z. z. o sprístupňovaní meradiel na trhu v znení nariadenia vlády SR č. 328/2019 Z. z., ktorým sa preberá smernica Európskeho parlamentu a Rady 2014/32/EU o harmonizácii právnych predpisov členských štátov týkajúcich sa sprístupnenia meradiel na trhu

Annex II, Module B to Government Ordinance of the Slovak Republic No. 145/2016 Coll. Relating to the making available on the market of measuring instruments as amended by Government Ordinance of the Slovak Republic No. 328/2019 Coll., which implemented the Directive 2014/32/EU of the European Parliament and of the Council on the harmonisation of the laws of the Member States relating to the making available on the market of measuring instruments

Žiadateľ/Výrobca:
Issued to (Manufacturer):

Arad Dalia Ltd.
Kibbutz Dalia 19239, Israel

Druh meradla:
Type of instrument:

Vodomer (MI-001)
Water meter (MI-001)

Označenie typu:
Type designation:

Octave High Flow

Základné požiadavky:
Essential requirements:

príloha č. 1 a príloha č. 3 Vodomery (MI-001) k nariadeniu vlády SR č. 145/2016 Z. z. v znení nariadenia vlády SR č. 328/2019 Z. z.

Annex No. I and Annex No. III Water meters (MI-001) to Government Ordinance of the Slovak Republic No. 145/2016 Coll. as amended by Government Ordinance of the Slovak Republic No. 328/2019 Coll.

Platnosť do:
Valid until:

20. august 2030
August 20, 2030

Notifikovaná osoba:
Notified body:

Slovenský metrologický ústav 1781
Slovak Institute of Metrology 1781

Dátum vydania:
Date of issue:

20. august 2020
August 20, 2020

Základné charakteristiky, popis meradla a podmienky schválenia sú uvedené v prílohe, ktorá je súčasťou tohto certifikátu. Certifikát vrátane prílohy má spolu 13 strán.

Essential characteristics, instrument description and approval conditions are set out in the appendix hereto, which forms the part of the certificate. The certificate including the appendix contains 13 pages.



Viliam Mazúr
zástupca notifikovanej osoby
representative of notified body

Poznámka: Tento certifikát EÚ skúšky typu môže byť rozmnožovaný len celý a nezmenený. Bez podpisu a odtlačku pečiatky je neplatný.
Note: This EU-type examination certificate shall not be reproduced except in full. Certificates without signature and stamp are not valid.

History of the Certificate

| Issue of the Certificate | Date | Modification |
|--------------------------------|-----------------|---------------------|
| SK 20-MI001-SMU063, Revision 0 | August 20, 2020 | Initial certificate |

1 Instructions and standards used within assessment
1.1 Generally binding instructions

Meter type was examined in terms of request for given type provisions Government Ordinance of the Slovak Republic No. 145/2016 Coll. relating to the making available on the market of measuring instruments as amended by Government Ordinance of the Slovak Republic No. 328/2019 Coll., which implemented the Directive 2014/32/EU of the European Parliament and of the Council of 26 February 2014 on the harmonisation of the laws of the Member States relating to the making available on the market of measuring instruments as later amended (next Government Ordinance).

Requirements are set out in Annex No. 1 and Annex No. 3 Water Meters (MI-001) to Government Ordinance of SR No. 145/2016 Coll. as amended by Government Ordinance of the Slovak Republic No. 328/2019 Coll..

1.2 Harmonized standards and normative documents used

| | |
|-------------------------|---|
| OIML R 49-1:2006 | Water meters intended for the metering of cold potable water and hot water. Part 1: Metrological and technical requirements |
| OIML R 49-2:2004 | Water meters intended for the metering of cold potable water and hot water. Part 2: Test methods |
| EN 14154-1:2005+A2:2011 | Water meters - Part 1: General requirements |
| EN 14154-2:2005+A2:2011 | Water meters - Part 2: Installation and conditions of use |
| EN 14154-3:2005+A2:2011 | Water meters - Part 3: Test methods and equipment |

1.3 Other instructions used:

| | |
|---------------------|---|
| OIML R 49-1:2013 | Water meters intended for the metering of cold potable water and hot water. Part 1: Metrological and technical requirements |
| OIML R 49-2:2013 | Water meters intended for the metering of cold potable water and hot water. Part 2: Test methods |
| OIML R 49-3:2013 | Water meters intended for the metering of cold potable water and hot water. Part 3: Test report format |
| EN ISO 4064-1: 2017 | Water meters for cold potable water and hot water. Part 1: Metrological and technical requirements |
| EN ISO 4064-2: 2017 | Water meters for cold potable water and hot water. Part 2: Test methods |
| EN ISO 4064-5: 2017 | Water meters for cold potable water and hot water. Part 5: Installation requirements |



2 Type marking
Ultrasonic water meter – Octave High Flow

Meter is made in following subgroups:

| Type of meter | Temperature class | Class | Nominal Diameter |
|---|-------------------|---|------------------|
| Octave High Flow Stainless Steel Floating Flanges connections | T50 | M1 ¹⁾ O ²⁾ E1 ¹⁾ | DN80 – DN200 |

3 Description of measuring instrument
Meter name: Octave High Flow is an ultrasonic water meter

Type marking: DN80 – DN200

Description of operating principle instrument design:

This pattern for a family of liquid measuring instruments for measuring the volume of cold water which has passed through them. They are an ultrasonic, flanged water cold-water meter having a Q_3 (permanent flowrate) from 160 m³/h for the 80 mm meter to 1000 m³/h for the 200 mm meter, all sizes with a Q_3/Q_1 turndown ratio of 250 and 500 (R250 and R500).

The Octave High Flow instruments are ultrasonic water meters, which use the Transit time method. This method is based on the physical phenomena where the speed of an ultrasonic wave propagation is equal to the sum of the speed of the flow and the speed of sound of the media at rest. By measuring the time of the wave propagation of both the upstream and downstream the flow, it is possible to obtain the fluid's velocity along the acoustical beam.

The meter does not include mechanical or moving parts, and is mainly consist of hollow tube body with couple of sensors and electronic measuring unit, when the PCB and software are prevented by polyurethane from water damage, according to IP68. The body of water meter could be with regular design or with reinforced design.

Water meters could be installing for mounting on pipelines in every possible position. The water meter designed to measure reverse flow.

All the meters can be pre-equipped for option of having a signal for remote reading purposes - automated computerized system (wireless metering system) for controlling of metering of delivered water quantity, which was not part of this certification.



¹ according to Government Ordinance of the Slovak Republic, Annex No. 1

² according to EN ISO 4064-1:2017 and OIML R 49-2:2013



Picture No.1 Octave High Flow Stainless-Steel Floating flanges models

3.1 Description of subgroups

Marking: Octave High Flow DN80-DN200

The meter can be equipped by following devices:

- Protective Crown
- Dialog 3G- Meters emitting a RF signal for remote reading purposes which was not part of this certification
- Encoder and Pulse out (SSR) – Wired communication, which transmit volume, alerts and ID.
- W-Mbus/OMS – RF translation of data, according to protocol request
- Pulse Output Module
- 4-20mA Output Module
- AMR Output Module
- Dry Contact

3.2 Measuring insert

The measuring unit group consists of the sealed capsule of measuring electronic unit, and the measuring tube with piezoelectric sensors.

3.3 Indicating device





The capacity of the counter is 999999999,999 m³ for size DN80 up to DN200 and minimum resolution of the reading is 0,01 Litre (In this case the dot replaced with hyphen). The measuring

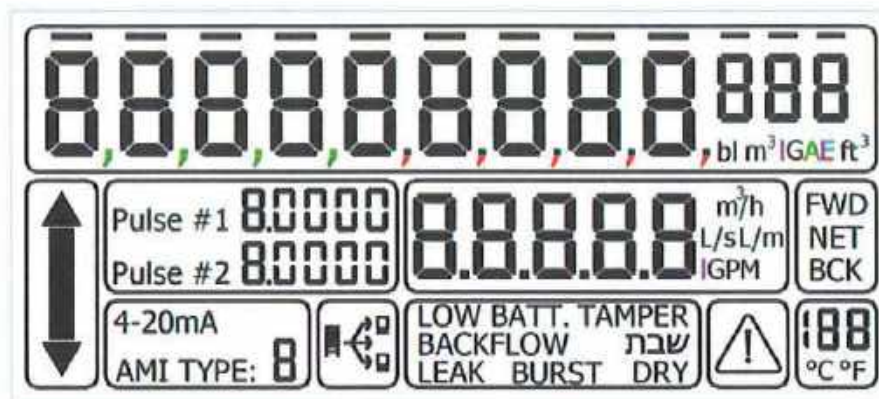

units, as the body as well, made of heavy composite materials and protect damage, contamination and humidity (according to IP68).

Black digits marked on digital drums or black pointers indicate cubic meters or their multiples whereas red digits pointers or small digits indicate submultiples of cubic meters.

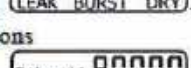
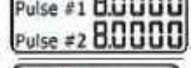
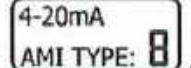

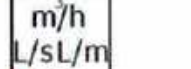
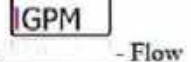
| | | |
|---|---|--|
| 1 | Volume accumulator include 9 large digits +3 small digits |  |
| 2 | New Icons |  <ol style="list-style-type: none"> 1.  - Display volume 2.  - Detecting icons 3.  - Pulse resolution 4.  - Outputs |
| 3 | Units |  <ol style="list-style-type: none"> 1.  - Volume 2.  - Flow |

Picture No.2: LCD display with key



3.4 Principle of operation

The potable water enters the meter from the inlet of the meter with initial speed. Sensors have sent ultrasonic pulses during water flow, and pulse velocity depend of water flow speed. Knowing the impulse velocity in stagnant water, a mathematical equation is solved, as a result of which, the flow velocity is established. The velocity, volume and the other information is recurred on LCD display. The water meter is designed to measure the flow rate and amount of supplied cold water and warm water.

3.5 Technical documentation

A number of drawings of technical documentations are listed in the following table:

| Drawing No. | Description |
|--------------|---|
| 13930022V402 | 13930022V402_OCTAVE DN 80 s.st full bore ISO R250 F.F-Approved-00 |
| 13940021V402 | 13940021V402_OCTAVE DN 100 s.st full bore ISO R250 F.F-Approved-00 |
| 13950021V402 | 13950021V402_Octave DN 150 s.st full bore ISO R500 F.F-Approved-00 |
| 13960021V402 | 13960021V402_OCTAVE DN 200 s.st full bore ISO R500 F.F.-Approved-00 |

All drawings, schemes and technical documentations used during the conformity assessment are saved in document No. NO-455/20/2.

4 Basic technical characteristics

| Type marking | | Octave High Flow | | | |
|--------------------------------------|----------------|--|-----|-----|-----|
| Nominal diameter DN | mm | 80 | 100 | 150 | 200 |
| Indicating range | m ³ | 10 ⁹ | | | |
| Resolution of the reading | m ³ | 0,00001 | | | |
| Maximum admissible pressure | - | MAP16 | | | |
| Working pressure range | bar | from 0,3 to 10 | | | |
| Pressure loss | - | Δp 10 | | | |
| Temperature class | - | T50 | | | |
| Flow profile sensitivity classes | - | U3, D3 | | | |
| Position | - | H, V | | | |
| Climatic and mechanical environments | - | closed spaces /from -25°C to 55°C/mech. class M1, class O for fixed meters installed outdoor | | | |
| Electromagnetic environments | - | E1 | | | |
| Reverse Flow | - | The meter may or may not measure reverse flow depending on factory set-up. This should be marked on the Data Label | | | |



4.1 Additional technical characteristics

| | |
|------------------------------------|--|
| Environmental protection (IP Code) | IP 68 |
| Weight | Specified the item 10.1 of this Annex |
| Power Supply | The electronic card is powered from two batteries size D. <ul style="list-style-type: none"> • Battery lithium Thionyl Chloride :3.6Vdc • Nominal capacity 19Ah • Rated voltage 3.6V • Maximum recommended continuous current 100 mA • Maximum 1 sec. pulse capability 200 mA • Volume 26 cc • Operating temperature range -55 °C to +85 °C • U.L. Component Recognition, MH 12193 |
| Data logger | Volumes and alarms data (48 kB, 4130 data points) |
| Display | LCD, 12 digits accumulation volume |
| Software | Type P, Extension I, Risk Class I (Welmec Guide 7.2, 2019) |
| Software version and checksum | 4.02; Checksum 9914E |

5 Basic metrological characteristics

The maximum permissible error (accuracy class):

$$\pm 5 \% (Q_1 \leq Q < Q_2)$$

$$\pm 2 \% (Q_2 \leq Q \leq Q_4) \text{ for water temperature (from 0,1 to 30) } ^\circ\text{C}$$

$$\pm 3 \% (Q_2 \leq Q \leq Q_4) \text{ for water temperature greater than 30 } ^\circ\text{C}$$

For Octave High Flow with R500:

| Nominal Diameter | DN | mm | 80 | 100 | 150 | 200 |
|-----------------------|------------|-------------------|-------|-------|-------|------|
| Minimum flowrate | Q_1 | m ³ /h | 0,32 | 0,5 | 1,26 | 2 |
| Transitional flowrate | Q_2 | m ³ /h | 0,512 | 0,8 | 2,016 | 3,2 |
| Permanent flowrate | Q_3 | m ³ /h | 160 | 250 | 630 | 1000 |
| Overload flowrate | Q_4 | m ³ /h | 200 | 312,5 | 787,5 | 1250 |
| Measuring range R | Q_3/Q_1 | - | 500 | | | |
| Ratio | Q_2/Q_1 | - | 1,6 | | | |
| Pressure loss | Δp | - | 10 | | | |



For Octave High Flow with R250:

| | | | | | | |
|-----------------------|------------|-------------------|-------|-------|-------|------|
| Nominal Diameter | DN | mm | 80 | 100 | 150 | 200 |
| Minimum flowrate | Q_1 | m ³ /h | 0,64 | 1,0 | 2,52 | 4 |
| Transitional flowrate | Q_2 | m ³ /h | 1,024 | 1,6 | 4,032 | 6,4 |
| Permanent flowrate | Q_3 | m ³ /h | 160 | 250 | 630 | 1000 |
| Overload flowrate | Q_4 | m ³ /h | 200 | 312,5 | 787,5 | 1250 |
| Measuring range R | Q_3/Q_1 | - | 250 | | | |
| Ratio | Q_2/Q_1 | - | 1,6 | | | |
| Pressure loss | Δp | - | 10 | | | |

6 Results of conformity assessment

The results of tests, assessments and evaluations given in the evaluation report No. NO-455/20/2/B/ER dated August 19, 2020 give sufficient evidence, that the technical design of the measuring instrument – Ultrasonic water meter – type Octave High Flow is in compliance with the technical requirements of the Slovak Republic Governmental Ordinance No. 145/2016 Coll. relating to the making available on the market of measuring instruments as amended by Government Ordinance of the Slovak Republic No. 328/2019 Coll., Annex No. 1 and Annex No. 3 Water Meters (MI-001) and the EN 14154-1:2005+A2:2011, EN 14154-2:2005+A2:2011, EN 14154-3:2005+A2:2011 and OIML R49-1:2006, OIML R49-2:2004 (harmonised standards and normative documents) and other instructions EN ISO 4064-1:2017, EN ISO 4064-2:2017 and EN ISO 4064-3:2014 standards, which are relevant for this type of meter.

7 Data placed on the measuring instrument

On the shroud, the dial of the indicating device or on an identification plate of every water meter or in the product documentation minimum the following data should be marked:

- a) Manufacturer's name, registered trade name or registered mark
- b) Postal address of manufacturer at which they can be contacted
- c) Type of the Ultrasonic water meter
- d) Measuring unit (m³)
- e) Numerical value of Q_3 in m³/h (Q_3 x,x) and ratio Q_3/Q_1 (Rxxx)
- f) Year of production
- g) Production serial number
- h) Number of EU-type examination certificate and conformity mark
- i) The highest admissible pressure if it differs from 1 MPa (MAP xx)
- j) Flow direction
- k) The letter V or H, if the meter can only be operated in the vertical or horizontal position
- l) Class of pressure loss if it differs from Δp_{63} (Δp XX)
- m) The installation sensitivity class where it differs from U0/D0 (Ux Dx)
- n) The temperature class where it differs from T30
- o) Environmental classification
- p) Electromagnetic environmental class
- q) For a non-replaceable battery: the latest date by which the meter shall be replaced





Picture No. 3 Data labels

8 Conditions of conformity assessment of measuring instruments produced with type approval

Ultrasonic water meter put onto the market in line with the procedure of conformity assessment according to the Annex No.2 (Module D or F) of the Governmental ordinance should be in compliance with the technical description by the item 3 of this report and at test should be in compliance with the requirements determined in OIML R 49-1:2013 and EN ISO 4064-1:2017. Metrological test is performed by testing equipment which should be in compliance with the requirements determined in EN 14154-3:2005+A2 and EN ISO 4064-2:2017 and water at temperature 20 °C ± 10 °C in following points of flowrate:

- a) Minimum flowrate $Q_1 \leq Q \leq 1,1Q_1$
- b) Transitional flowrate $Q_2 \leq Q \leq 1,1Q_2$
- c) Permanent flowrate $0,9Q_3 \leq Q \leq Q_3$

A metrological test may only be performed by a producer, or a notified body respectively in line with the conformity assessment procedure according to the Annex No.2 (Module D or F) of the Governmental ordinance respectively.

9 Measures asked for providing measuring instrument integrity

9.1 Identification

Ultrasonic water meter should be in compliance with the description provided on item 3 of this Annex and should be in compliance with the marking specified the item 7 of this Annex. The number given to the EU-type examination certificate is put at each piece of the measuring instrument.

Emplacement of the conformity mark is followed by § 15 of the Governmental ordinance.

9.2 Sealing of the measuring instrument

Ultrasonic water meter shall be sealed before the conformity assessment according to the Annex No.2 (Module D or F) of the Governmental ordinance sealed by following sealing marks:

The Octave High Flow meter has five plastic seals (Picture No. 4 and No. 5):

- two seals are placed on the Sensor Cover Plates screws, one on each plate. On plastic bodies the sensor covers are seals,
- two seals are implemented on the meter Face Plate,
- one seal covers the screw of the Comm. output cover.

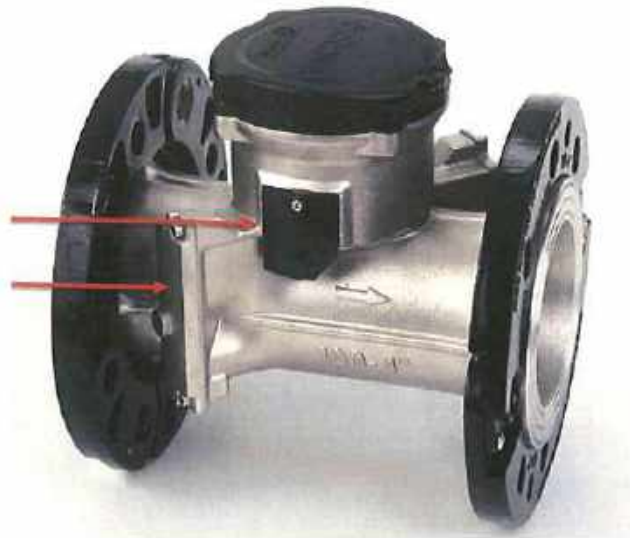

Picture No.4 Emplacement of the seals for security measures





Picture No.5 Emplacement of the seals for security measures



Picture No.6 Protective Crown



9.2.1 Software Security

The Octave Water Meter incorporates “Built for Purpose “software (Type P). Access to CPU, for software revisions, can only be done via a specific J-Tag connector on the PCB. In order to reach the PCB the meter must be disassembled:

- breaking two (2) seals,
- breaching the vacuumed Electronics Compartment.

The legal parameters are stored on a read-only memory. The legally relevant software is identified by a CRC-16. The user software is not identified by a CRC.

The user software (GUI) does not contain or store any legally relevant data. Once connected – it reflects the setup stored in the meter to the user software.

It allows the user to set the meter outputs and functionality, without the ability to change the accuracy or the way the meter is measuring.

The connection between the meter and the user software is either RS232 UART or NFC , in both cases any “set” command is validated by a CRC to ensure it came as expected.

The present software version 4.02 is shown on the data label (Picture No.5 and No. 6).

10 Requirements for installation, especially conditions of usage
10.1 Installation data:

| Model | | Octave High Flow | | | |
|--|--------|------------------|-------|-------|-------|
| Nominal size | [mm] | DN80 | DN100 | DN150 | DN200 |
| | [inch] | 3 | 4 | 6 | 8 |
| <i>L</i> - Length without couplings [mm] | | 225 | 250 | 300 | 350 |
| <i>W</i> - Width [mm] | | 200 | 220 | 285 | 340 |
| <i>H</i> - Overall Height [mm] | | 230 | 255 | 304 | 345,5 |
| <i>h</i> - Height above axis [mm] | | 110 | 115 | 143 | 172,5 |
| Weight [kg] <i>stainless steel body</i> | | 11 | 14.3 | 22 | 32 |

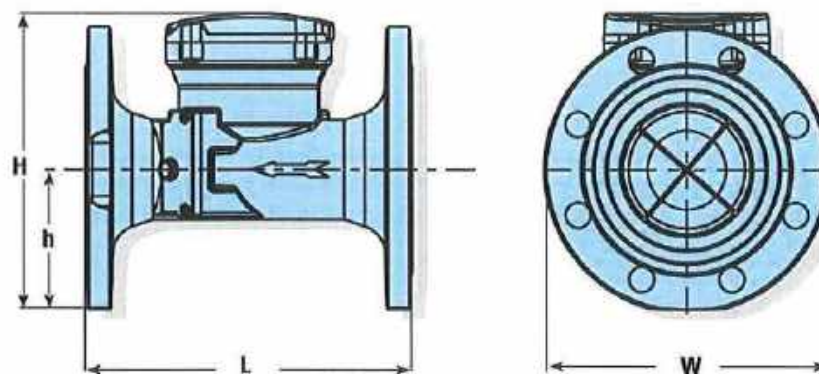

Picture No.7 Installation dimensions - Flanged



10.2 Installation requirements

The Ultrasonic water meter is introduced into the operation by a worker having a certificate for this activity performance. The Ultrasonic water meter is possible to be put into use after a construction in line with this report and in line with a producer instruction by "Instruction of installation and conditions of use of water meters". A measuring instrument should be installed in direction of water flow arrow marked on the meter body.

10.3 Conditions of use

Within using the measuring instrument, it is needed to be managed by recommendations of a producer by "Instruction of installation and conditions of use of water meters".

Assessment done by: Ing. Viliam Mazúr

